

CHECKLINE®
MADE TO MEASURE

Series F

Digital Force Testers

F105 | F305 | F505 | F505H | F755 | F755S | F1505 | F1505S

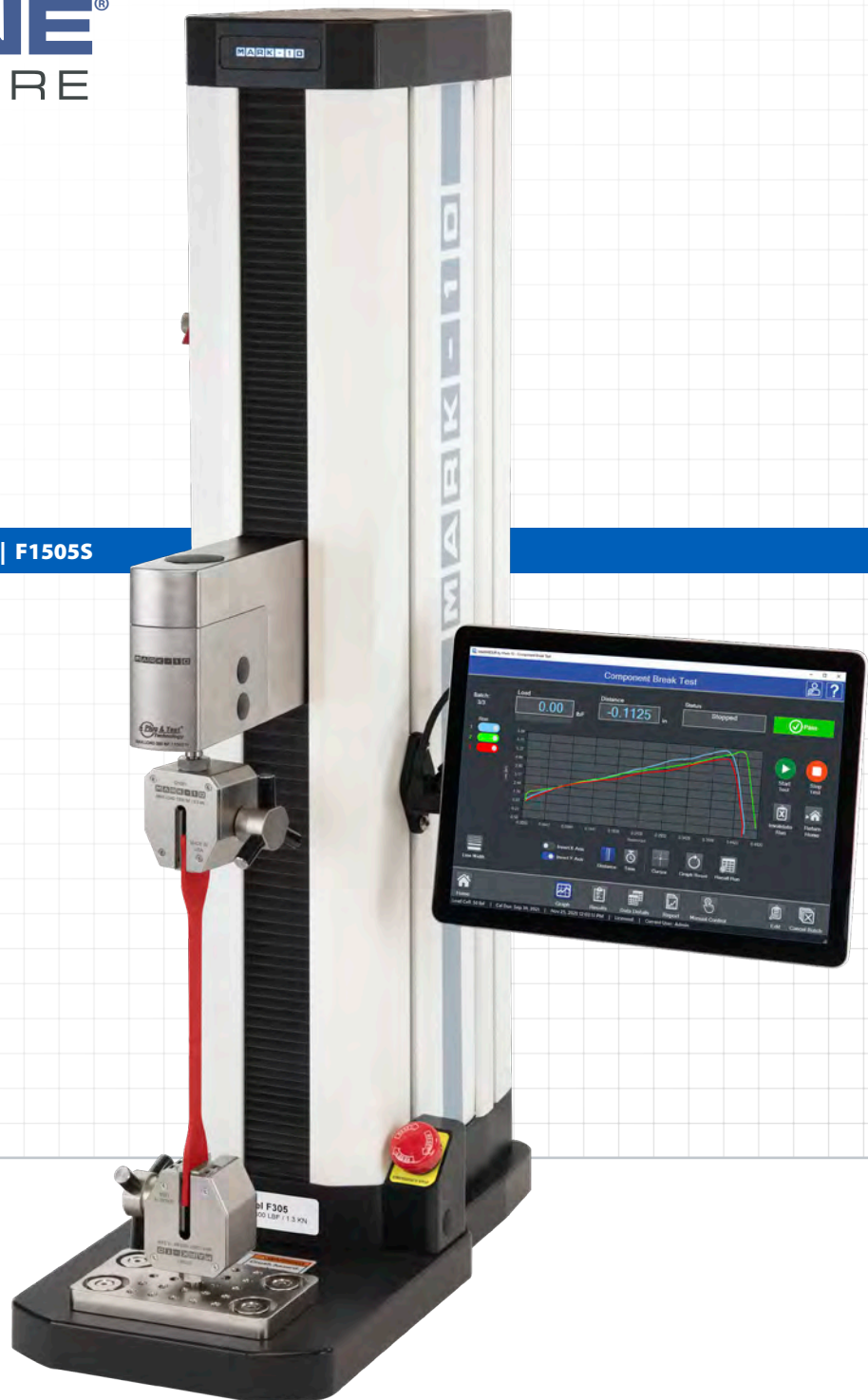

Force Measurement Re-imagined

Series F Tension / Compression Test Frames are engineered for force testing applications up to 1,500 lbF (6.7 kN). Select from a broad range of force sensor capacities and an expansive array of grips and fixtures.

Set up tests, record data, and analyze data via IntelliMESUR® software. From basic tests to multi-step sequencing, IntelliMESUR® is fully integrated with Series F systems. Select from a pre-configured tablet control panel or standalone software for your own Windows device.

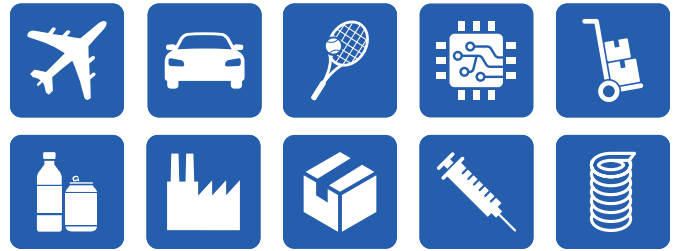

Virtually limitless applications

From food packaging to electronics, from consumer products to aerospace manufacturing, Mark-10 force test frames are at home in laboratory and production environments in virtually every industry worldwide.



Peel testing



Wire tensile testing

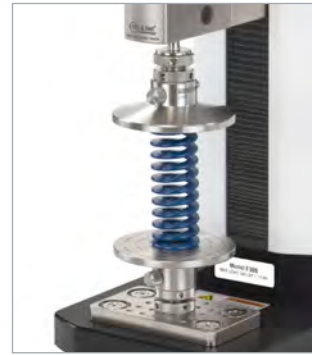

Compression spring testing



90° peel testing



Score bend testing



Tension spring testing

Table of Contents

Test Frames.....	03
IntelliMESUR®.....	05
Serviceability.....	11
Accessories.....	12
Specifications.....	15
Ordering Information.....	21



Engineered For Performance

There's a Series F test frame for every need and budget. Select from a wide range of force capacities, heights, and form factors.



F105 | F305 | F505

F755 | F1505

F755S | F1505S

F505H

	F105	F305	F505	F505H	F755	F755S	F1505	F1505S
Force Capacity:	100 lbF [0.5 kN]	300 lbF [1.5 kN]	500 lbF [2.2 kN]	500 lbF [2.2 kN]	750 lbF [3.4 kN]	1,500 lbF [6.7 kN]	1,500 lbF [6.7 kN]	1,500 lbF [6.7 kN]
Travel Distance:	18.0 in [457 mm]	18.0 in [457 mm]	18.0 in [457 mm]	18.0 in [457 mm]	32.0 in [813 mm]	14.2 in [360 mm]	32.0 in [813 mm]	14.2 in [360 mm]

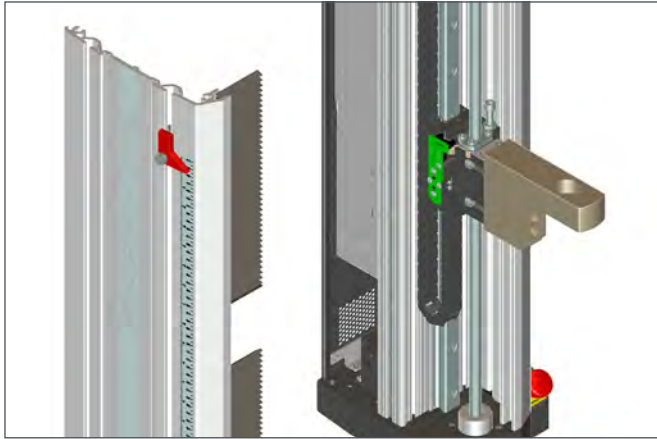

Rigid and precise mechanical design

Exceptionally rigid frames feature custom extrusion designs, engineered for stiffness. Factory compensation of test frames and force sensors ensure **position accuracy of ± 0.002 in / 0.05 mm** under any load, at any position.

Stepper motors and controllers drive a ballscrew and linear guideway for smooth, quiet operation, with virtually no speed variation under load.



Seamless force sensor interface

Series FS05 smart force sensors mount directly to the crosshead of models F105, F305, F505, and F505H, without any connection cables. Ranges available from 0.12 to 500 lbf [0.5 N to 2.5 kN]. Accurate to **$\pm 0.1\%$ of full scale**.

Series R07 S-beam type force sensors accommodate higher force ranges, also compatible with Plug & Test® technology. Ranges available from 50 to 1,500 lbf [250 N to 7.5 kN]. Accurate to **$\pm 0.15\%$ of full scale**.



Modular design

Frame bases can be removed to accommodate column extensions and alternative mounting configurations. Most electronics are housed in a self-contained enclosure, easily accessed and replaced if needed. Integrated T-slots along the column accommodate add-ons, such as a USB hub.

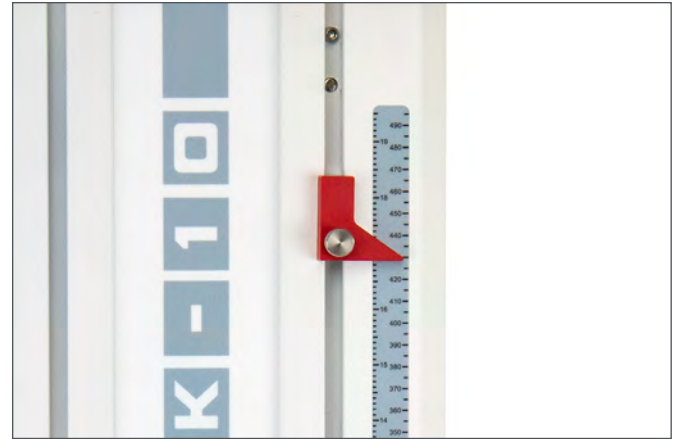

External limit switches

Solid-state upper and lower limit switches may be used as test limits or as test exceptions. Dual-graduated rulers aid in switch placement.



An integrated motion control and data collection solution

M IntelliMESUR®

IntelliMESUR® software is an integrated solution running on Windows tablets and PCs. Select a pre-loaded 10.1" tablet with mounting bracket or use your own Windows device. With IntelliMESUR®, you can create and run a wide range of basic and multi-step tests, including:

- Limit testing to a load, break, or distance
- Height measurement
- Load holding
- Cycle testing
- Multi-step testing, utilizing any combination of motion control and data collection functions

Perform individual runs or batches, and view data in graphical format or results tables. Save or export data as needed, or generate a report.

Ready. Set. Go.

From IntelliMESUR's home screen, quickly access up to 10 favorite tests. Associate an image with each favorite for easy identification.

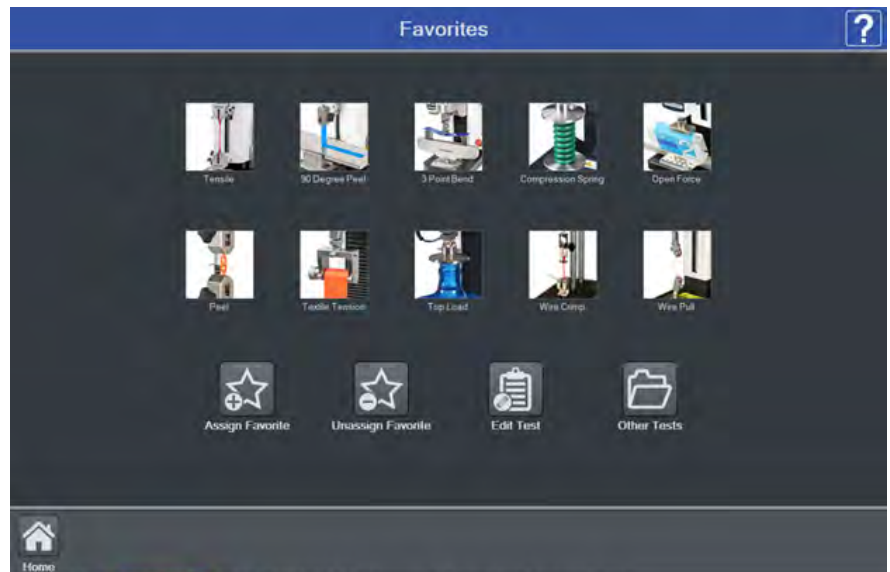

What's your point of view?

Run a test via the Graph or Results views, and switch views as needed. Pass / Fail indicator easily identifies problematic samples. Individual runs may be invalidated if, for example, the sample slips out of the grips, or the test was interrupted.

Graph view

The Graph view plots force vs. distance or force vs. time. Overlay up to 10 runs for visual comparisons.

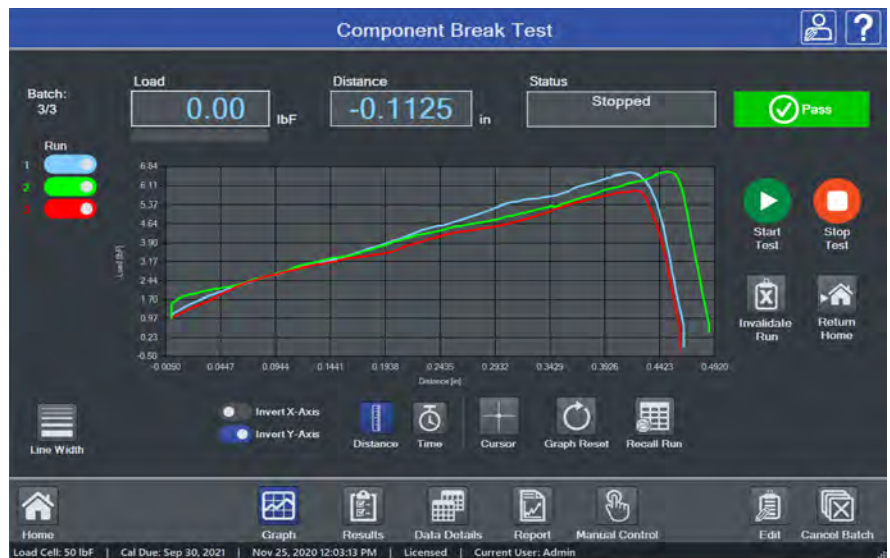

Results view

The Results view displays user-selected results for each run. Statistics may be applied to selected results.

Run No.	Status	Serial Number	Date	Time	Speed (in/min)	Final Load (lbF)	Max Load (lbF)	Max Distance (in)
1	Pass	12345	Nov 25, 2020	12:02:02 PM	10.00	0.12	6.62	0.4640
2	Pass	45678	Nov 25, 2020	12:02:19 PM	10.00	0.46	6.64	0.4870
3	Pass	98765	Nov 25, 2020	12:02:33 PM	10.00	0.30	5.92	0.4610

Max						0.46	6.64	0.4870
Min						0.12	5.92	0.4610
Mean						0.02	6.40	0.4705
Std. Dev						0.3243	0.3348	0.0116
Variance						0.1052	0.1121	0.0001

Test setup is easy as 1-2-3

Basic tests

Select a test type, and IntelliMESUR® will guide you through the setup.



Load Limit



Distance Limit



Break Limit



Load Hold



Cycle

1. Pre-Test Settings

- Units of measurement
- Batch size
- Display preferences
- Preload
- Operator prompts

2. Test Settings

- Test objective
- Speed
- Pass / fail limits
- Exception limits

3. Results & Statistics Selection

- Final load
- Maximum load
- Minimum load
- Load at max. distance
- Load at min. distance
- Load at break
- Average load
- Delta load
- Maximum distance
- Final distance
- Minimum distance
- Height
- Distance at max. load
- Distance at min. load
- Distance at break
- Delta distance

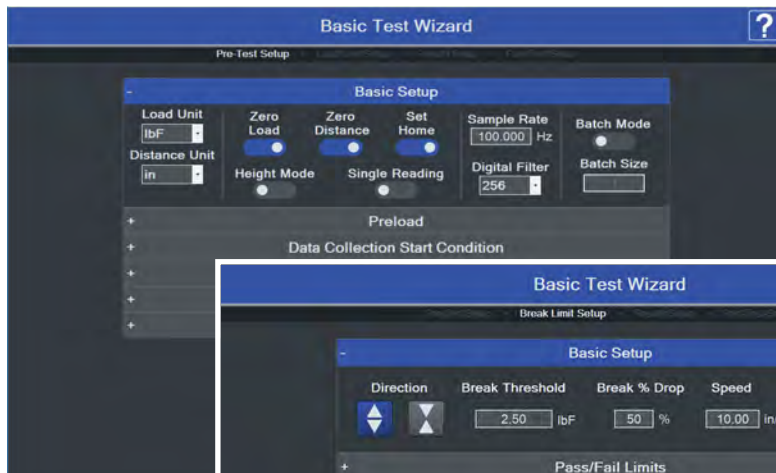

Pre-Test Settings

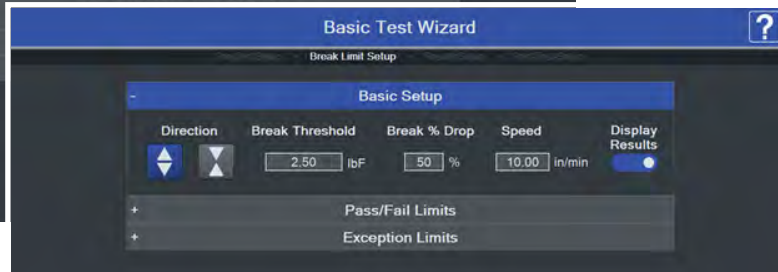

Test Settings



Results & Statistics Selection

Multi-step tests

Building upon basic test wizards, easily incorporate any combination of steps, with the ability to loop a sequence of steps. Select from:

- Move to load
- Move to distance
- Move to break
- Hold a load or position
- Loop / cycle
- Datum
- Prompts
- Save current load or position
- Zero load or position
- Return to Home position



Insert and re-order steps as necessary

Operator prompting

Prompts can appear at the beginning of each test, batch, or run.

Ask prompts ask the operator for information which is saved in the results table - for example, a lot number. Type the response or use a barcode scanner.

Tell prompts provide instructions to the operator, and can include an image.

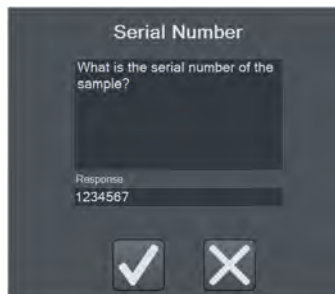

Ask Prompt



Tell Prompt

Take your measurements to new heights

Use **Height Mode** to determine height at a specific load, commonly used in spring testing. A datum may be set to define the reference point.



Deflection compensation

Series F test frames and force sensors are deflection-compensated at the factory, resulting in system distance measurement accuracy of **±0.002 in / 0.05 mm** at any load and at any position along the frame. To further compensate grips and attachments, use IntelliMESUR®'s deflection compensation utility. The deflection offset file can be associated with the test setup file.



Robust data acquisition and management

Blazingly fast

Force sensor sampling rate of **20,000 Hz** yields accurate peak measurements even in quick-duration events. IntelliMESUR® collects load and travel data at up to **1,000 Hz**, and allows up to 1 million data points per run.

Customizable reporting

Print or create a PDF report, including results, statistics, graph, system and user information, and comments. Personalize the report with your company logo and an additional image.

Create report templates to save with future reports.

Save or export data

Automatically or manually save individual runs and results to a USB drive or file location of your choice. File names are automatically generated with the test name and time stamp, for quick searchability.

Results sets and data from individual runs may also be exported as .csv files.

Run No.	Status	Serial Number	Date	Time	Speed (in/min)	Max Load (lbf)	Max Distance (in)
1	Pass	12345	11-Dec-20	12:43:37 PM	10	-4.34	0.3805
2	Pass	98760	11-Dec-20	12:43:48 PM	10	-4.54	0.365
3	Pass	02468	11-Dec-20	12:43:58 PM	10	-5.16	0.375

Statistics	Status	Date	Time	Speed (in/min)	Max Load (lbf)
Maximum					5.60
Minimum					5.02
Mean					5.28
Std. Dev.					0.2424
Variance					0.0588

Results .csv output

Peel Test

Peel Test.txt

A batch of T-peel tests were performed on 1" samples, at a rate of 6 in/min. Peak results were obtained and compared against pass/fail criteria.

Equipment used
 - F305 test frame
 - FS05-20 load cell
 - G1008 grips

System information:
 IntelliMESUR Version: 1.0.0
 Frame Model: F305
 Test Frame Serial Number: 1234567
 Test Frame Capacity: 300 lbf / 1.5 kN
 Test Frame Firmware Version: 1.00.00
 Load Cell Model: RM105-0
 Load Cell Serial Number: 9876543
 Calibration Date: Sep 30, 2020
 Calibration Due Date: Sep 30, 2021

Run No.	Status	Date	Time	Speed (in/min)	Max Load (lbf)
1	Pass	Dec 22, 2020	04:22:45 PM	10.00	5.60
2	Pass	Dec 22, 2020	04:22:51 PM	10.00	5.20
3	Pass	Dec 22, 2020	04:22:57 PM	10.00	5.02

Statistics	Status	Date	Time	Speed (in/min)	Max Load (lbf)
Maximum					5.60
Minimum					5.02
Mean					5.28
Std. Dev.					0.2424
Variance					0.0588

Graph

All samples passed.

PDF report

Secure user access

Control user access with three permissions levels:

- **Administrators** have full access.
- **Supervisors** can create a test, run reports, calibrate force sensors, and change settings.
- **Operators** may recall and run a test, but cannot create a test or perform more advanced functions.



Intelligent manual control

Manually control the test frame to obtain quick force and distance results, or manually position the crosshead prior to a test. Select from several actuation methods, including momentary (button-hold), maintained (button release) motion, jog mode with three distance presets.



With Mark-10's innovative **FollowMe®** function, push and pull on the force sensor to move the crosshead. Apply greater force to achieve faster motion. FollowMe® is responsive enough for quick positioning as well as fine adjustments.



FollowMe®

The **Height / Length Offset** utility in Manual Control defines a reference point to accommodate applications in which grips cannot directly touch one another.

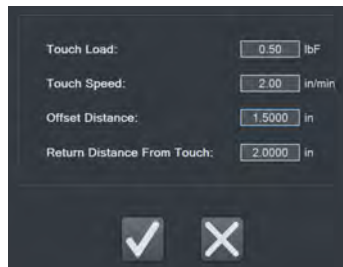

Uniquely serviceable

Calibrate force sensors on the test frame or off-site

Calibrate Series FS05 and R07 force sensors in one of two ways:

Test frame

IntelliMESUR® provides an integrated utility, with an intuitive step-by-step wizard. Manual controls allow the technician to use the test frame to apply tension and compression forces.

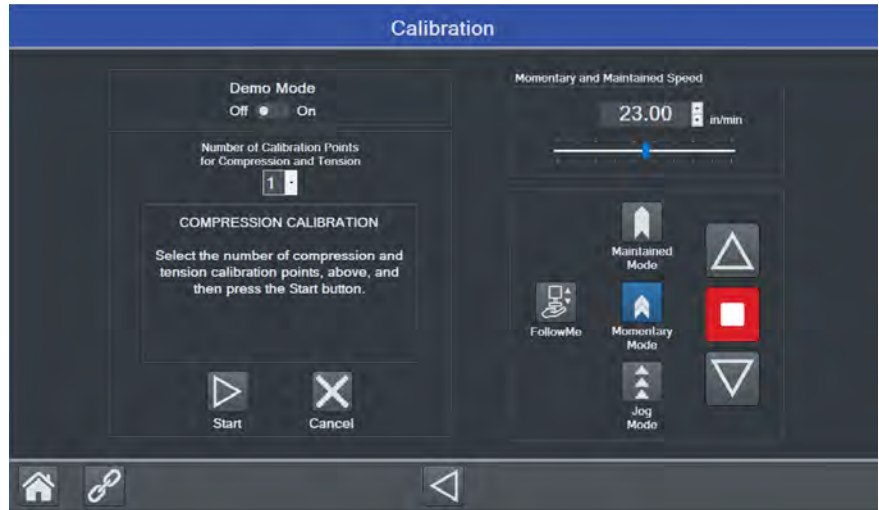

Off-site

Conveniently remove the force sensors for off-site calibration with a Mark-10 Model M71 or M51 indicator.



FS05 force sensor connected to an M51 indicator via AC1083 adapter for off-site calibration

Field-upgradeable

Test frame firmware and IntelliMESUR® software can be updated in the field via a simple user interface. No need to schedule a service call or to ship hardware to the factory.



Easy-to-service electronics

Most electronics are housed in an integrated module, easily replaced without special tools or processes.



Removing the electronics module

In The Box



F105 / F305 / F505 / F505H

- Control panel, mounting bracket, and hardware (-IMT models only)
- Mounting bracket, column end (F505H only)
- USB flash drive containing software installation files (-IM models only)
- USB dongle (-IM models only)
- USB cable
- #10-32M medium hook
- 5/16-18M large hook
- #10-32F 2" diameter compression plate
- #10-32 M/F 2" extension rod
- #10-32 F/F coupler
- Adapter, 5/16-18M to #10-32F
- Set screw, #10-32 x 3/4"
- Hex nut, #10-32 (2)
- Power cord
- Allen wrench set
- NIST-traceable certificate of calibration, force



F755 / F755S / F1505 / F1505S

- Control panel, mounting bracket, and hardware (-IMT models only)
- USB flash drive containing software installation files (-IM models only)
- USB dongle (-IM models only)
- USB cable
- Eye end kit for base
- Lock ring for eye end (2)
- Spanner wrench (2)
- Power cord
- Allen wrench set
- NIST-traceable certificate of calibration, force

Optional Accessories



Column Extensions for Models F105 / F305 / F505 / F505H

Select from single- and double-column extensions for oversized samples. Three heights are available - 6, 12 and 24 in [150, 300, and 600 mm]. Double-column extensions accommodate up to a 20 in. [508 mm] wide sample, or $\varnothing 21.5$ in [$\varnothing 546$ mm] round sample. Base contains rows of T-slots for fixture mounting. Double column extensions not available for F505H.

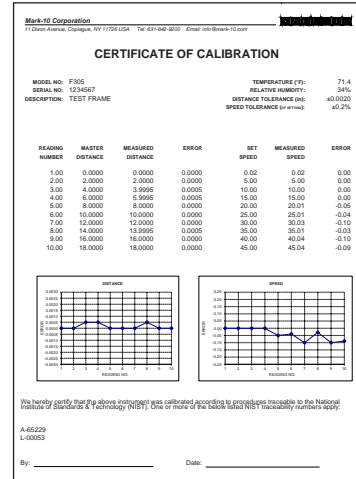

Certificate of Calibration - Distance & Speed (CERT-DS)

NIST-traceable certificate of calibration for test frame distance measurement and speed.



Safety Shield for Models F105 / F305 / F505 (AC1086)

Provides pinch and sample debris protection for the operator. The shield rotates open and closed with smooth, effortless actuation. An electrical interlock prevents test stand operation while the door is open. Includes a remote emergency stop switch.



Safety Shield for Models F755 / F755S / F1505 / F1505S (AC1092-1, AC1092-2)

Provides pinch and sample debris protection for the operator. An electrical interlock prevents test stand operation while the door is open. The tablet control panel and included remote emergency stop switch can be mounted to the shield's extruded frame. Also compatible with Models F105, F305, and F505 with up to 24 in / 600 mm column extensions.



USB Hub (AC1093)

Test frame-mounted 4-port USB hub improves cable management and conveniently accommodates peripherals, such as a flash drive, barcode scanner, etc. Compatible with all Series F test frames.



Adapter, FS05 to Plug & Test® Connector and Extension (AC1083, AC1084)

Adapts a Series FS05 force sensor or PTAF sensor adapter to Plug & Test® type interface, for ease of external calibration via a Mark-10 indicator. Also permits mounting of a Series FS05 sensor to Models F755, F755S, F1505, and F1505S test frames. Shown above with Model M5I indicator and AC1084 extension cable (48 in. / 1,220 mm).



Third-party Force Sensor Adapter (PTAF)

Adapts a user-supplied force sensor to Models F105, F305, F505, and F505H test frames, and Models M5I and M7I indicators. AC1083 adapter required for Models F755, F755S, F1505, and F1505S test frames. Use the included software utility to select from a library of common force capacities. Requires a Model M5I or M7I indicator for configuration.

SPECIFICATIONS

	F105	F305	F505	F505H	F755	F755S	F1505	F1505S
Load capacity*:	100 lbF [0.5 kN]	300 lbF [1.5 kN]	500 lbF [2.2 kN]		750 lbF [3.4 kN]		1,500 lbF [6.7 kN]	
Maximum travel:	18.0 in [457 mm]				32.0 in [813 mm]	14.2 in [360 mm]	32.0 in [813 mm]	14.2 in [360 mm]
Speed range:	0.02 - 45 in/min [0.5 - 1,110 mm/min]				0.001 - 60 in/min [0.02 - 1,525 mm/min]		0.001 - 70 in/min [0.02 - 1,800 mm/min]	
Load accuracy (% of full scale):	Test frame: $\pm 0.1\%$ Force sensor: Series F505: $\pm 0.1\%$ Series R07: $\pm 0.15\%$							
Load sampling rate:	20,000 Hz							
Data acquisition rate:	1,000 Hz							
Speed accuracy:	$\pm 0.2\%$ of setting, virtually no variation with load							
Distance accuracy:	± 0.002 in [0.05 mm], factory-compensated at up to full load							
Distance resolution:	0.0005 in / 0.01 mm							
Limit switch repeatability:	± 0.001 in / 0.03 mm							
Power:	Universal input 100-240 VAC, 50/60 Hz, 300W				Universal input 100-240 VAC, 50/60 Hz, 120W		Universal input 100-240 VAC, 50/60 Hz, 450W	
Fuse type:	1.2 A, 250V, 3AG, SLO BLO				4A, 3AG, SLO BLO			
Weight:	60 lb [27 kg]		70 lb [32 kg]		184 lb [83 kg]	149 lb [68 kg]	197 lb [89 kg]	157 lb [71 kg]
Shipping weight:	75 lb [34 kg]		85 lb [39 kg]		235 lb [107 kg]	195 lb [88 kg]	247 lb [112 kg]	205 lb [93 kg]
Environmental conditions:	<ul style="list-style-type: none"> ▪ Indoor use only ▪ Up to 6,500 ft [2,000 m] above sea level ▪ Temperature range: 40 - 95°F [5 - 35°C] ▪ Humidity range: up to 80% relative humidity at 31°C, decreasing linearly to 50% relative humidity at 40°C, non condensing ▪ Mains supply voltage fluctuations up to $\pm 10\%$ of the nominal voltage ▪ Transient overvoltages up to the levels of Overvoltage Category II ▪ Use in environments up to Pollution Degree 2 							
Conformance:	CE							
Warranty:	3 years [see individual statement for further details]							

* Load capacity is reduced at higher speeds in the following models:

- F305: limited to 200 lbF [1 kN] above 24 in [610 mm]/min
- F505 / F505H: limited to 300 lbF [1.5 kN] above 24 in [610 mm]/min
- F755 / F755S: limited to 500 lbF [2.3 kN] above 35 in [900 mm]/min
- F1505 / F1505S: limited to 1,000 lbF [4.5 kN] above 60 in [1,525 mm]/min

Dimensions in (mm)

Models F105 | F305 | F505

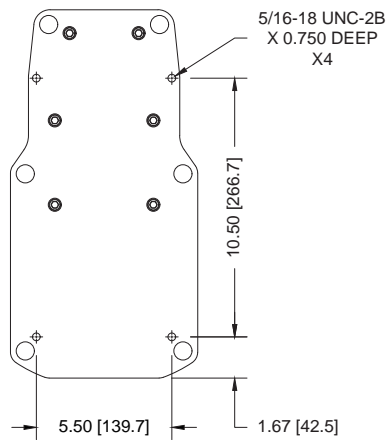
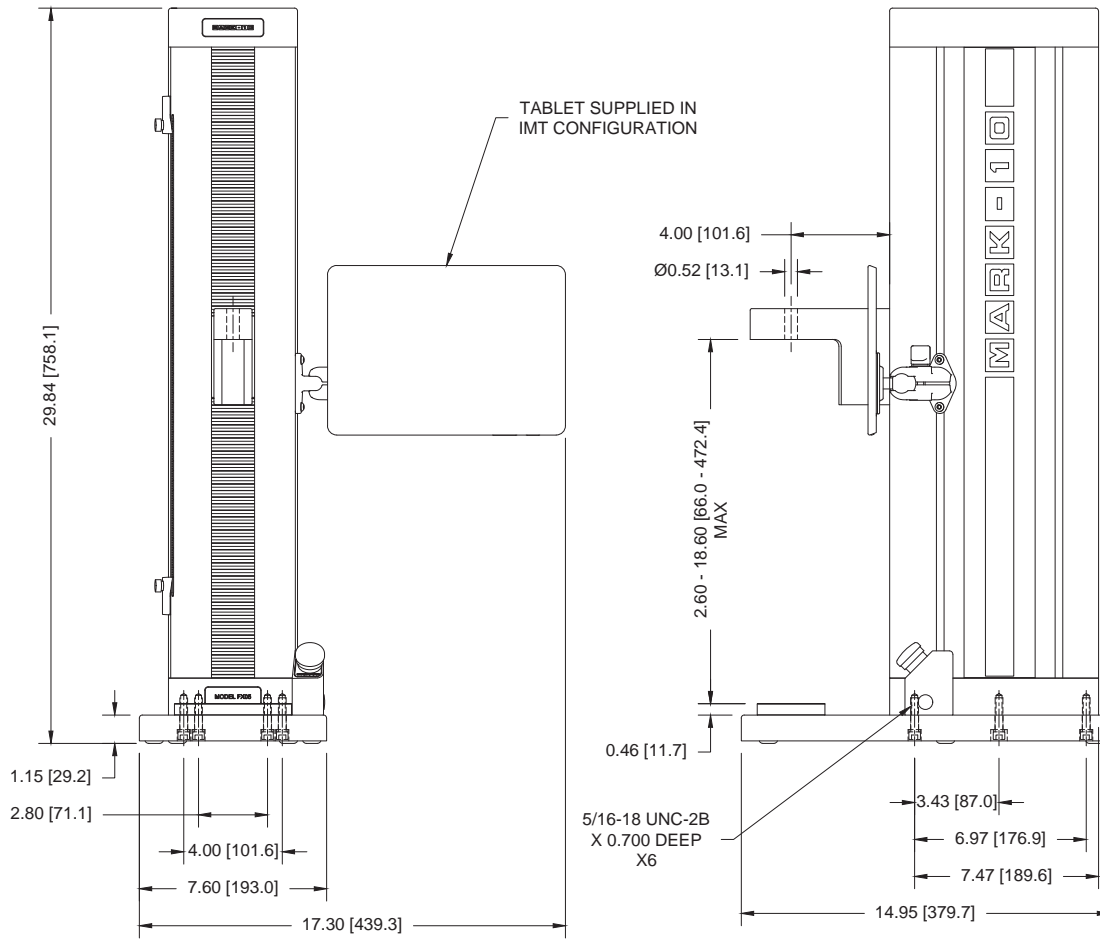

**BENCH MOUNTING HOLES
BOTTOM VIEW**

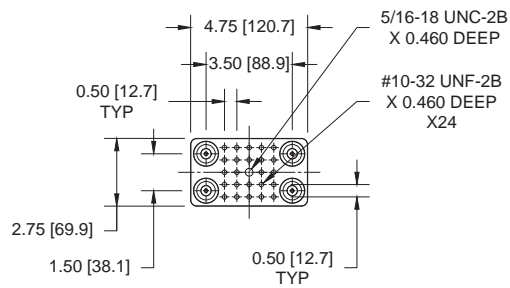

**MOUNTING PLATE
TOP VIEW**

Model F505H

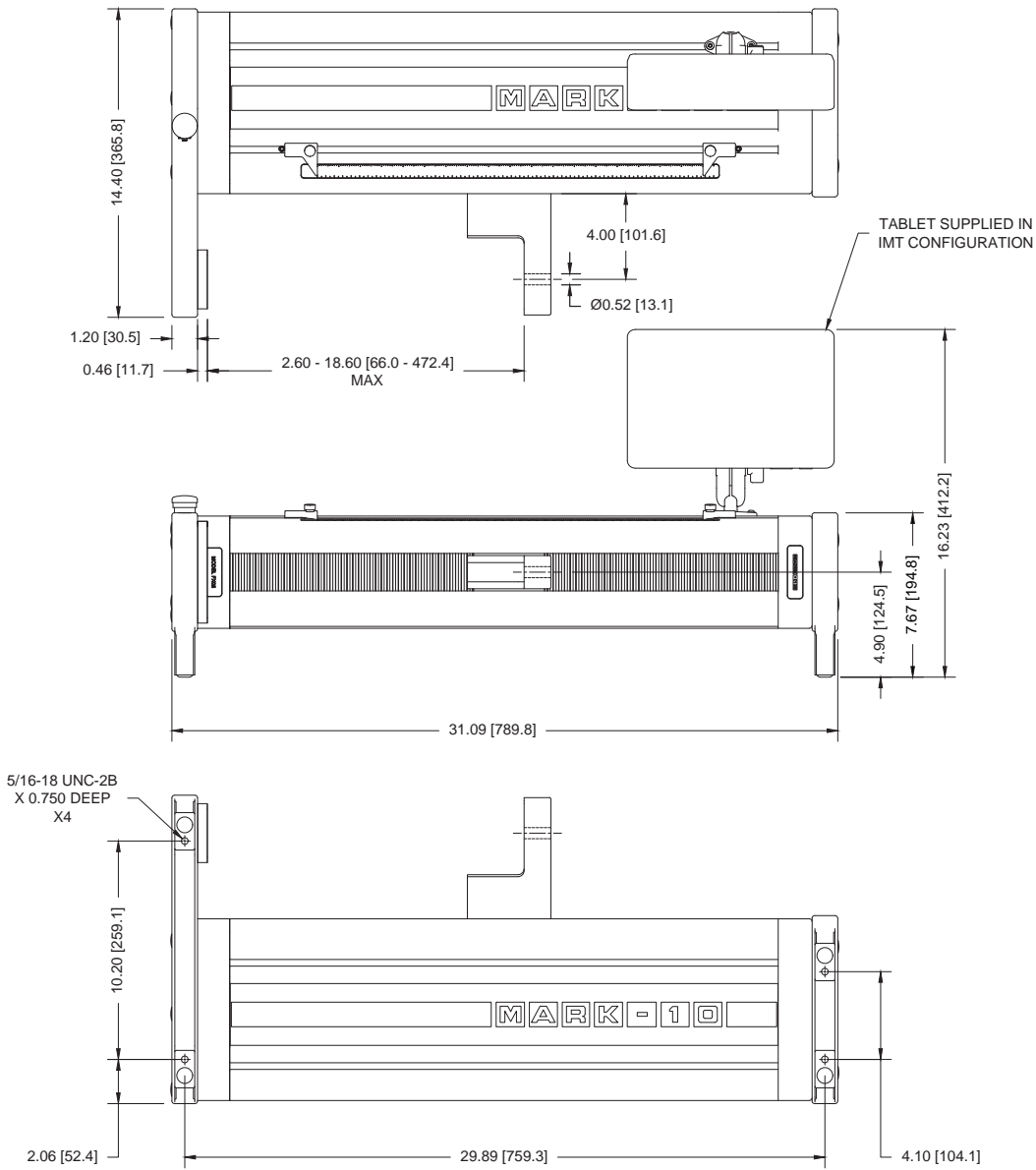

BENCH MOUNTING HOLES BOTTOM VIEW

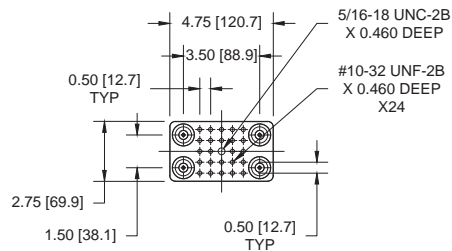

MOUNTING PLATE TOP VIEW

SPECIFICATIONS

Models F755 | F755S | F1505 | F1505S

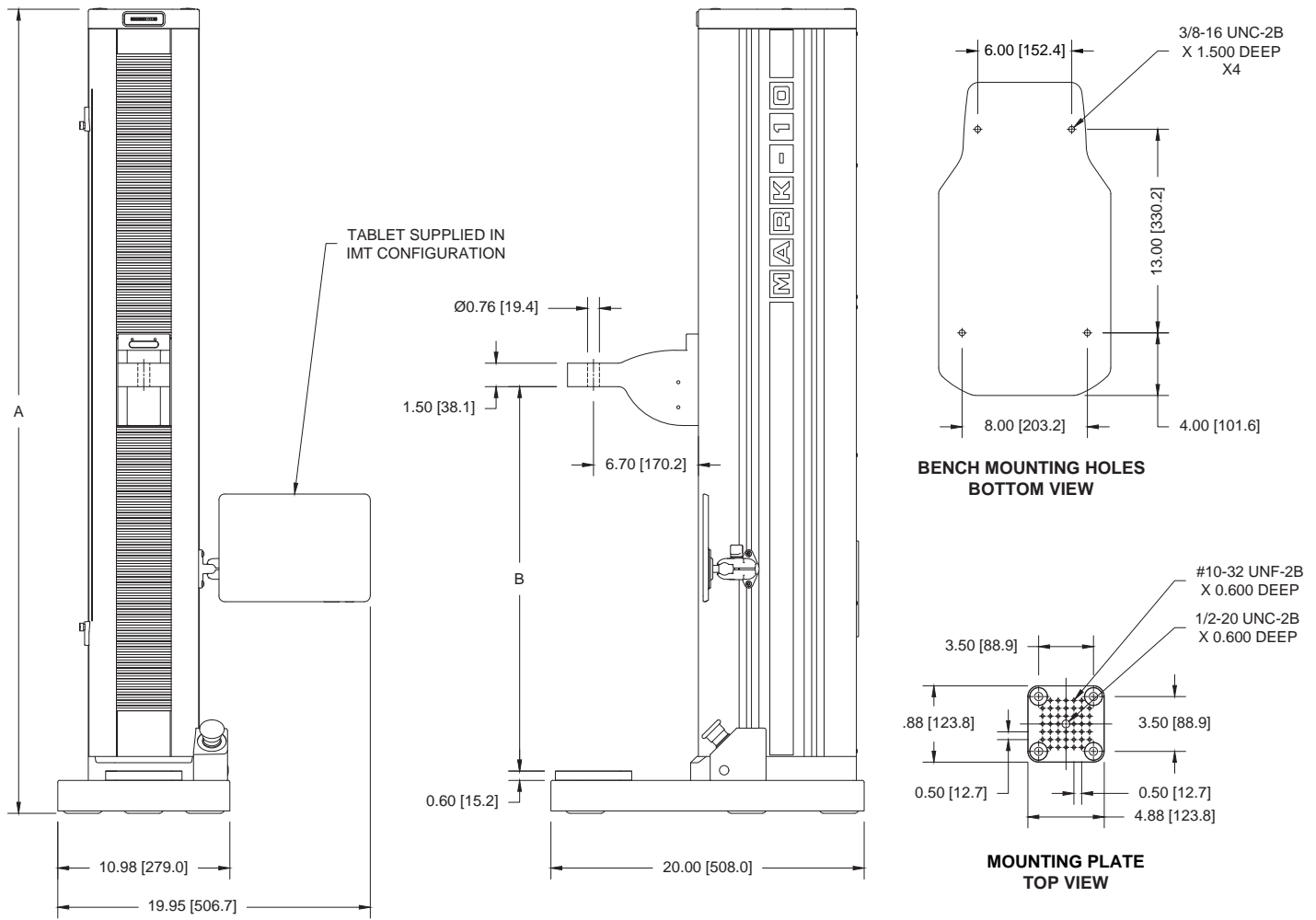

	F755	F755S	F1505	F1505S
A	51.35 [1304.3]	33.89 [860.9]	50.85 [1291.6]	33.39 [848.1]
B	8.13 - 40.13 [206.4 - 1019.2]	8.13 - 22.33 [206.4 - 567.1]	8.13 - 40.13 [206.4 - 1019.2]	8.13 - 22.33 [206.4 - 567.1]

Series FS05 Force Sensors

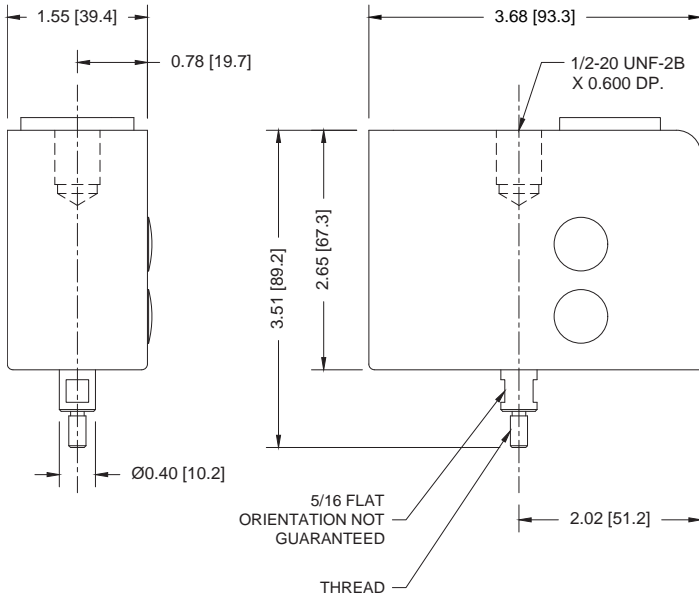

Model No.	Thread
FS05-012 - FS05-100	#10-32 UNF
FS05-200 - FS05-500	5/16-18 UNC

Series R07 Force Sensors

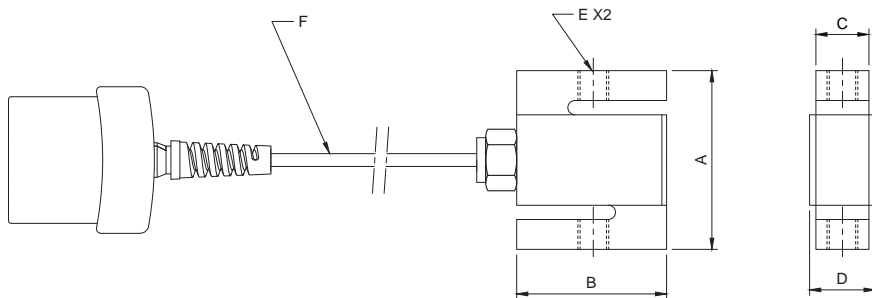

Model No.	A	B	C	D	E	F
MR07-50	2.40 [61.0]	2.00 [50.8]	0.46 [11.7]	0.90 [22.9]	1/4-28 UNF	10.00 [254.0]
MR07-100						
MR07-200						
MR07-300			0.71 [18.0]	1.10 [27.9]	1/2-20 UNF	
MR07-500						
MR07-750						
MR07-1000						
MR07-1500	0.96 [24.4]	1.40 [35.6]				

Complete Systems - Test Frame with Pre-configured Tablet Control Panel

Model No.	Description
F105-IMT	Test frame with IntelliMESUR® pre-loaded tablet control panel, vertical, 100 lbF / 0.5 kN, 110V*
F305-IMT	Test frame with IntelliMESUR® pre-loaded tablet control panel, vertical, 300 lbF / 1.5 kN, 110V*
F505-IMT	Test frame with IntelliMESUR® pre-loaded tablet control panel, vertical, 500 lbF / 2.2 kN, 110V*
F505H-IMT	Test frame with IntelliMESUR® pre-loaded tablet control panel, horizontal, 500 lbF / 2.2 kN, 110V*
F755-IMT	Test frame with IntelliMESUR® pre-loaded tablet control panel, vertical, 750 lbF / 3.4 kN, 110V*
F755S-IMT	Test frame with IntelliMESUR® pre-loaded tablet control panel, vertical, short, 750 lbF / 3.4 kN, 110V*
F1505-IMT	Test frame with IntelliMESUR® pre-loaded tablet control panel, vertical, 1,500 lbF / 6.7 kN, 110V*
F1505S-IMT	Test frame with IntelliMESUR® pre-loaded tablet control panel, vertical, short, 1,500 lbF / 6.7 kN, 110V*

Test Frame + Standalone Software (for customer installation on a Windows device)

Model No.	Description
F105-IM	Test frame with IntelliMESUR® software, single license, vertical, 100 lbF / 0.5 kN, 110V*
F305-IM	Test frame with IntelliMESUR® software, single license, vertical, 300 lbF / 1.5 kN, 110V*
F505-IM	Test frame with IntelliMESUR® software, single license, vertical, 500 lbF / 2.2 kN, 110V*
F505H-IM	Test frame with IntelliMESUR® software, single license, horizontal, 500 lbF / 2.2 kN, 110V*
F755-IM	Test frame with IntelliMESUR® software, single license, vertical, 750 lbF / 3.4 kN, 110V*
F755S-IM	Test frame with IntelliMESUR® software, single license, vertical, short, 750 lbF / 3.4 kN, 110V*
F1505-IM	Test frame with IntelliMESUR® software, single license, vertical, 1,500 lbF / 6.7 kN, 110V*
F1505S-IM	Test frame with IntelliMESUR® software, single license, vertical, short, 1,500 lbF / 6.7 kN, 110V*

Select a complete system or frame + software
Select a force sensor (required - see next page)

* All test frame models contain a universal power supply (80 - 240V) and power cord with US prong style. Add suffix 'E' for European prong, 'U' for UK prong, or 'A' for Australian prong. Ex: F505-IMTE.

Series FS05 Force Sensors

Compatible with Models F105, F305, F505. and F505H. Adapter part no. AC1083 is required for Models F755, F755S, F1505, and F1505S.



Model No.	Capacity x Resolution						
	lbF	ozF	gF	kgF	N	kN	mN
FS05-012	0.12 x 0.00002	2 x 0.0005	50 x 0.01	-	0.5 x 0.0001	-	500 x 0.1
FS05-025	0.25 x 0.0001	4 x 0.002	100 x 0.05	-	1 x 0.0005	-	1000 x 0.5
FS05-05	0.5 x 0.0002	8 x 0.005	250 x 0.1	-	2.5 x 0.001	-	2500 x 1
FS05-2	2 x 0.001	32 x 0.02	1000 x 0.5	1 x 0.0005	10 x 0.005	-	-
FS05-5	5 x 0.002	80 x 0.05	2500 x 1	2.5 x 0.001	25 x 0.01	-	-
FS05-10	10 x 0.005	160 x 0.1	5000 x 2	5 x 0.002	50 x 0.02	-	-
FS05-20	20 x 0.01	320 x 0.2	10000 x 5	10 x 0.005	100 x 0.05	-	-
FS05-50	50 x 0.02	800 x 0.5	25000 x 10	25 x 0.01	250 x 0.1	-	-
FS05-100	100 x 0.05	1600 x 1	50000 x 20	50 x 0.02	500 x 0.2	-	-
FS05-200	200 x 0.1	3200 x 2	-	100 x 0.05	1000 x 0.5	1 x 0.0005	-
FS05-300	300 x 0.2	4800 x 5	-	150 x 0.1	1500 x 1	1.5 x 0.001	-
FS05-500	500 x 0.2	8000 x 5	-	250 x 0.1	2500 x 1	2.5 x 0.001	-

Select one or more force sensors (required)

Series R07 Force Sensors

Compatible with Models F755, F755S, F1505, and F1505S. Cannot be used with Models F105, F305, F505. and F505H.



Model No.	Capacity x Resolution					
	lbF	ozF	gF	kgF	N	kN
MR07-50	50 x 0.02	800 x 0.5	25000 x 10	25 x 0.01	250 x 0.1	-
MR07-100	100 x 0.05	1600 x 1	50000 x 20	50 x 0.02	500 x 0.2	-
MR07-200	200 x 0.1	3200 x 2	-	100 x 0.05	1000 x 0.5	1 x 0.0005
MR07-300	300 x 0.2	4800 x 5	-	150 x 0.1	1500 x 1	1.5 x 0.001
MR07-500	500 x 0.2	8000 x 5	-	250 x 0.1	2500 x 1	2.5 x 0.001
MR07-750	750 x 0.5	12000 x 10	-	375 x 0.2	3750 x 2	3.75 x 0.002
MR07-1000	1000 x 0.5	16000 x 10	-	500 x 0.2	5000 x 2	5 x 0.002
MR07-1500	1500 x 1	24000 x 20	-	750 x 0.5	7500 x 5	7.5 x 0.005

Accessories

Model No.	Description
CERT-DS	Certificate of calibration, distance and speed
AC1094-1	Single column extension, 6 in / 150 mm, F105 / F305 / F505 / F505H
AC1094-2	Single column extension, 12 in / 300 mm, F105 / F305 / F505 / F505H
AC1094-3	Single column extension, 24 in / 600 mm, F105 / F305 / F505 / F505H
AC1095-1	Double column extension, 6 in / 150 mm, F105 / F305 / F505
AC1095-2	Double column extension, 12 in / 300 mm, F105 / F305 / F505
AC1095-3	Double column extension, 24 in / 600 mm, F105 / F305 / F505
AC1086	Safety shield, F105 / F305 / F505
AC1092-1	Safety shield, F755S / F1505S
AC1092-2	Safety shield, F755 / F1505
AC1093	USB hub
AC1083	Adapter, FS05 sensor / PTAF adapter, to Plug & Test® connector / F755, F755S, F1505, F1505S test frames, 10 in / 250 mm cable
AC1084	Extension cable, 48 in / 1,220 mm, Plug & Test®, male/female
PTAF	Adapter, Plug & Test®, customer-supplied force sensor to Series F test frames
DC5000	Spare tablet control panel, pre-installed with IntelliMESUR®, with test frame mounting hardware
15-1019	IntelliMESUR® software, customer installation on a Windows device, additional seat



Applications are virtually limitless...

Mark-10 force and torque measurement products help quality control, engineering, and manufacturing professionals assess and ensure quality in virtually every industry worldwide.